

ONDULINE SYSTEM

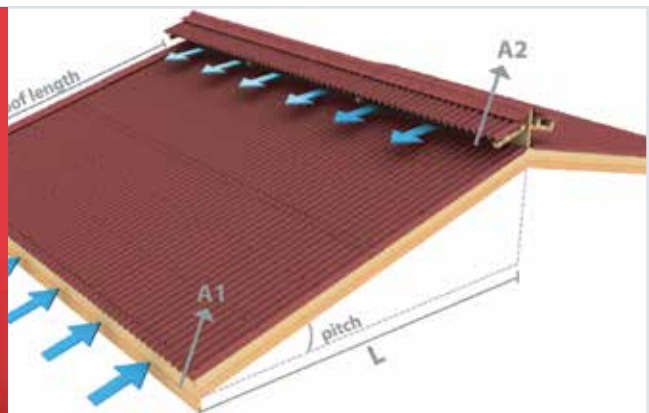

TECHNICAL BOOK



Onduline[®]

www.onduline.com

INDEX

1 . SUMMARY / GENERAL

4

1.1	SHEET LAYOUT	4
1.2	OVERLAPPING RULES	4
1.3.1	WOOD FRAME WITH ROOF PITCHES OVER 15° (>27%)	5
1.3.2	WOOD FRAME WITH ROOF PITCHES 10° - 15° (17% - 27%)	6
1.3.3	WOOD FRAME WITH ROOF PITCHES 5° - 10° (9% - 17%)	7
1.4.1	METAL FRAME WITH ROOF PICHES OVER 15° (>27%)	8
1.4.2	METAL FRAME WITH ROOF PITCHES 10° - 15° (17% - 27%)	9
1.4.3	DETAILED FIXING STEPS	10

2 . INSTALLATION DETAILS

11

2.1	RIDGES	11
2.2	EDGES / VERGES	12
2.3	EAVES	12
2.4	HIP DETAILS	13
2.5	EAVES TRAY	13
2.6	EAVES VENTILATION STRIP	13
2.7	END WALL ABUTMENTS	14
2.8	SIDE WALL ABUTMENTS	14
2.9	END ROOF	15
2.10	VALLEY	15
2.11	ONDULINE ROOF WINDOW	16
2.12	SKYLIGHT - ONDUCLAIR	16
2.13	ROOF VENTILATOR	16
2.14	CHIMNEYS	17
2.15	CURVED ROOFS / DOMES	18

3 . PRODUCT SPECIFICATIONS

19

3.1	ONDULINE CLASSIC SHEET	19
3.2	ONDULINE RIDGE	19
3.3	ONDULINE VERGE	19
3.4	ONDULINE NAIL	20
3.5	ONDULINE SCREW	20
3.6	ONDUBAND®	20
3.7	ONDULINE MULTI-PUPOSE EAVES TRAY	20
3.8	ONDULINE VENTILATED EAVES FILLER	20
3.9	ONDULINE ROOF VENTILATORS	21
3.10	ONDULINE ROOF WINDOW / SKYLIGHT	21
3.11	ONDULINE APRON FLASHING	21
3.12	ONDULINE SOIL PIPE	21

4 . VENTILATION

22

4.1	ROOF VENTILATION	22
4.2	RELATIVE HUMIDITY / MOISTURE LEVEL WITHIN BUILDING	23
4.3	VENTILATION BETWEEN ROOF LAYERS	24

5 . CERTIFICATES

25

6 . GENERAL INFORMATION

26

1. SUMMARY / GENERAL

1.1 SHEET LAYOUT

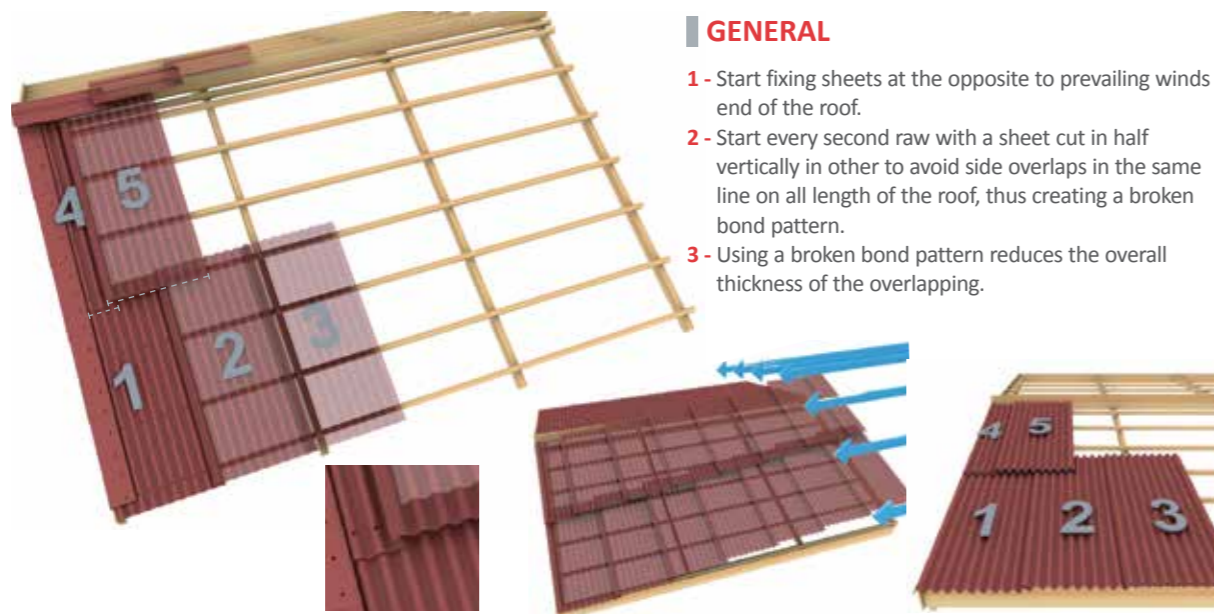

GENERAL

- 1 - Start fixing sheets at the opposite to prevailing winds end of the roof.
- 2 - Start every second row with a sheet cut in half vertically in other to avoid side overlaps in the same line on all length of the roof, thus creating a broken bond pattern.
- 3 - Using a broken bond pattern reduces the overall thickness of the overlapping.

1.2 OVERLAPPING RULES

Following the overlapping rules is important to ensure a total waterproofing over time. Side and end overlapping vary according to the roof pitches.

ROOF PITCHES	> 15° (over 27%)	10° - 15° (17% - 27%)	5° - 10° (9% - 17%)
Maximum purlin distance	61 cm 	45 cm 	Full deck or close batten
Overhang at eaves	7 cm 	7 cm 	7 cm
Minimum end overlap	17 cm 	20 cm 	30 cm
Minimum side overlap	1 corrugation 	1 corrugation 	2 corrugations

1.3.1 WOOD FRAME WITH ROOF PITCHES OVER 15° (> 27%)



FRAME

For roof pitches over 15 degrees, ONDULINE sheet shall be supported by purlins with maximum width distance of **61 cm**.

In particularly high conditions of temperature and humidity please ask our technical service.



FIXING

19 nails should be hammered per sheet.

- Every corrugation should be nailed at eaves, overlaps and ridges.
- 1 corrugation out of 2 should be nailed at 2nd and 3rd intermediate purlin

To have a longlasting and garanted roof, it is mandatory to follow the nailing order and pattern.



OVERLAP

- For the end overlap, use minimum **17 cm**.
- For the side overlap, use minimum **1 corrugation**.

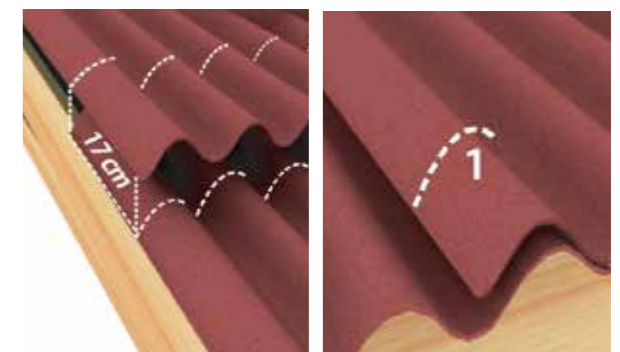

1.3.2 WOOD FRAME WITH ROOF PITCHES 10° - 15° (17% - 27%)



FRAME

For roof pitches 10 to 15 degrees, ONDULINE sheet shall be supported by purlins with maximum width distance of 45 cm.



FIXING

18 nails should be hammered per sheet.

- 9 nails at each corrugation at the end overlap or eaves.
- 3 nails at first intermediate purlin of the sheet.
- 3 nails at second intermediate purlin of the sheet.
- 3 nails at third intermediate purlin of the sheet.

Nails should be hammered at each corrugation at the end overlap and side overlap.

To have a longlasting and garanted roof, it is mandatory to follow the nailing order and pattern.



OVERLAP

- For the end overlap, use minimum 20 cm.
- For the side overlap, use minimum 1 corrugation.

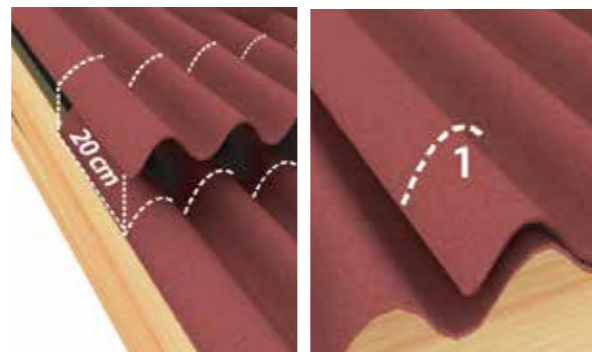

1.3.3 WOOD FRAME WITH ROOF PITCHES 5° - 10° (9% - 17%)



FRAME

For roof pitches 5 to 10 degrees, ONDULINE sheet shall be supported by full deck frame or close battening.



FIXING

16 nails should be hammered per sheet.

- 8 nails at each corrugation at the end overlap or eaves.
- 2 intermediate rows of 4 nails.

Nails should be hammered at each corrugation at the end overlap and side overlap.

To have a longlasting and garanted roof, it is mandatory to follow the nailing order and pattern.



OVERLAP

- For the end overlap, use minimum 30 cm.
- For the side overlap, use minimum 2 corrugations.

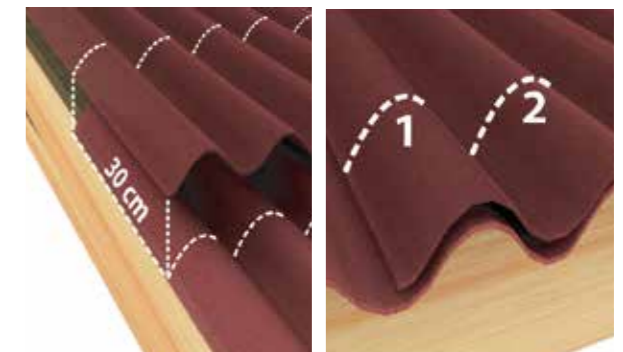

1.4.1 METAL FRAME WITH ROOF PITCHES OVER 15° (>27%)



FRAME

For roof pitches over 15 degrees, ONDULINE sheet shall be supported by purlins with maximum width distance of **61 cm**. In particularly high conditions of temperature and humidity please ask our technical service.

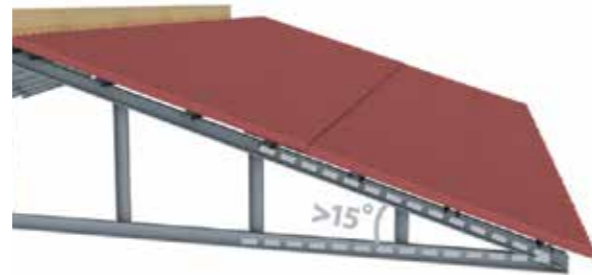

FIXING

11 screws should be drilled per sheet

- 5 screws at each corrugation at the end overlap or eaves.
- 3 screws at first intermediate purlin of the sheet.
- 3 screws at second intermediate purlin of the sheet.

Screws should be drilled at each corrugation at the end overlap and side overlap.
To have a longlasting and garanted roof, it is mandatory to follow the nailing order and pattern.



OVERLAP

- For the end overlap, use minimum **17 cm**.
- For the side overlap, use minimum **1 corrugation**.

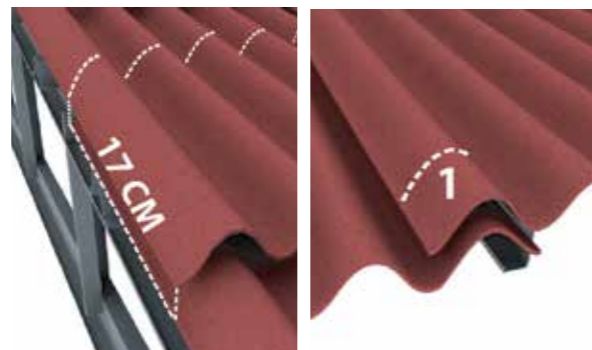

1.4.2 METAL FRAME WITH ROOF PITCHES 10° - 15° (17% - 27%)



FRAME

For roof pitches 10 to 15 degrees, ONDULINE sheet shall be supported by purlins with maximum width distance of **45 cm**.

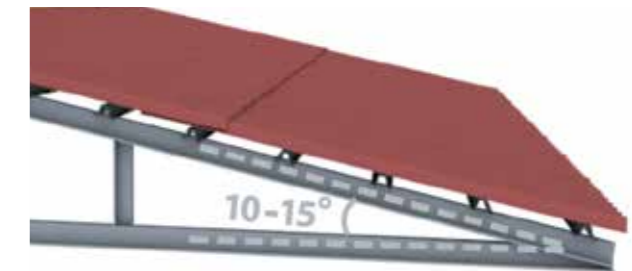

FIXING

14 screws should be drilled per sheet.

- 5 screws at each corrugation at the end overlap or eaves.
- 3 screws at first intermediate purlin of the sheet.
- 3 screws at second intermediate purlin of the sheet.
- 3 screws at third intermediate purlin of the sheet.

Screws should be drilled at each corrugation at the end overlap and side overlap.
To have a longlasting and garanted roof, it is mandatory to follow the nailing order and pattern.



OVERLAP

- For the end overlap, use minimum **20 cm**.
- For the side overlap, use minimum **1 corrugation**.

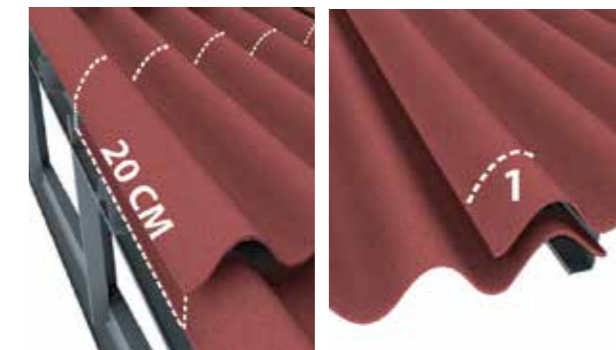

1.4.3 DETAIL FIXING STEPS

- To have a longlasting and garanted roof, it is mandatory to follow the fixing order and pattern.

! Use only ONDULINE recommended fasteners

- Fix every corrugation at eaves, sheets overlaps and either side of vertical joints.
- Fix every corrugation on intermediate purlins.
- Fastening must always be carried out at the top of corrugation.

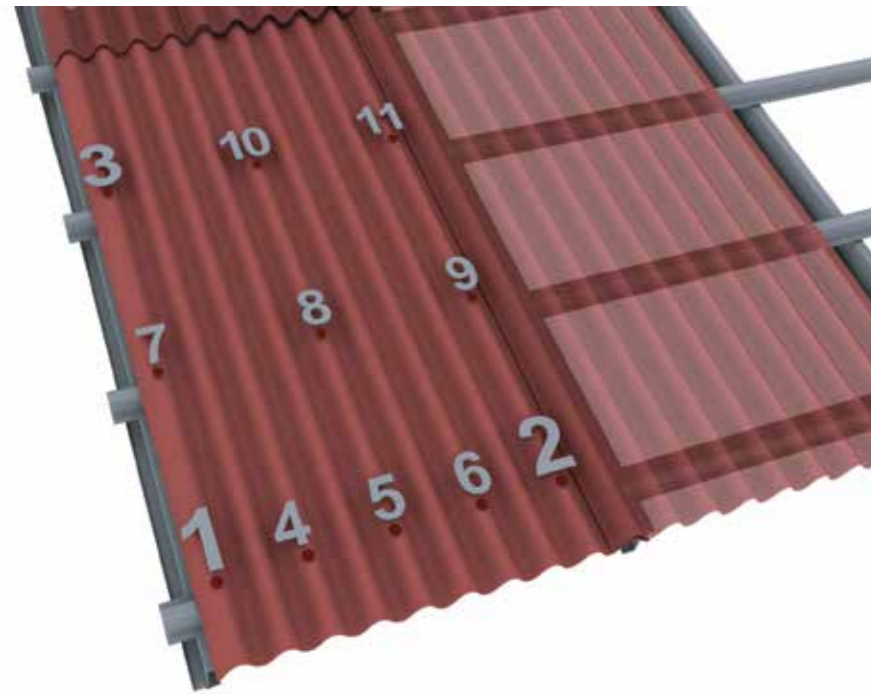

1 - Select the correct type of drill screw to suit purlin type.

2 - Drive the drill screw through the top of the corrugation.

3 - Be careful to avoid over compressing of the corrugation.



2. INSTALLATION DETAILS

2.1 RIDGES

- 1 - Use a **ridge plank** to support the ridge.
- 2 - The ridge element should be fastened at each corrugation of the overlapped sheet.
- 3 - Add an **extra purlin** when necessary if the distance between the last purlin and the ridge is too wide.



- 4 - Start fixing the ridge element at opposite to the prevailing winds end of the roof.
- 5 - The ridge element should overlap the ONDULINE® sheet minimum **12 cm**.
- 6 - Lay ridge elements with a minimum overlap of **12.5 cm**.

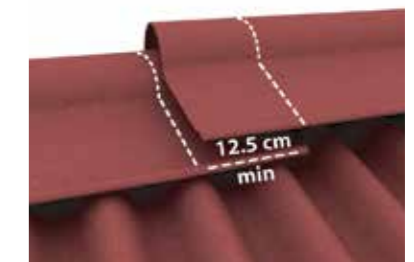
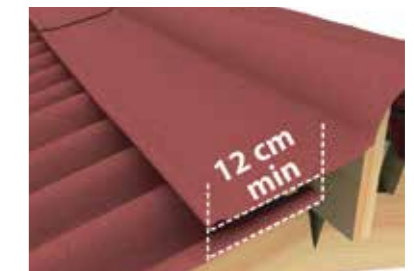
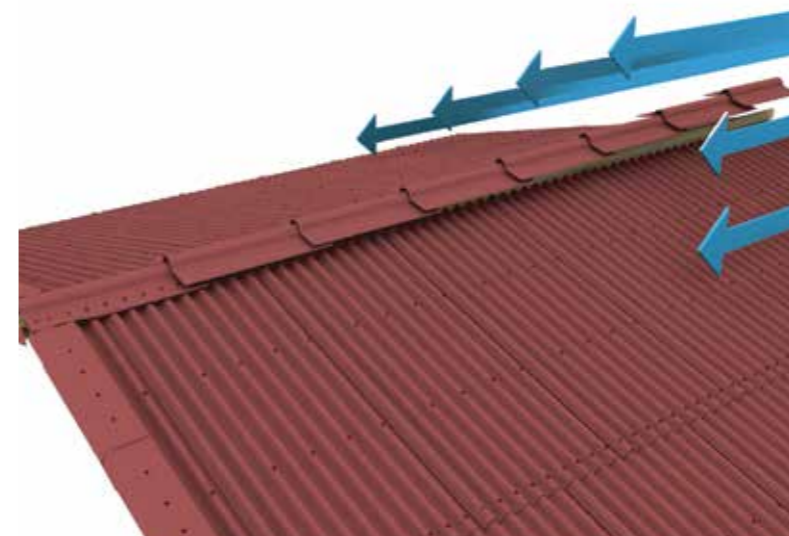

7 - A ridge cap can be cut out of the flat part of a ridge element.

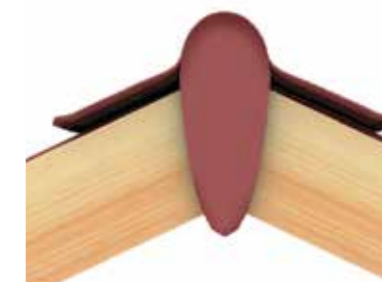
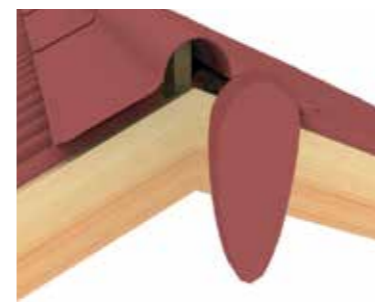

2.2 EDGES / VERGES

COVERING WITH AN ONDULINE VERGE ELEMENT

- 1 - Fasten bargeboard level with top of ONDULINE sheet.
- 2 - The ONDULINE verge is then overlaid and nailed into position.
- 3 - It is possible to use a ridge element for this purpose.

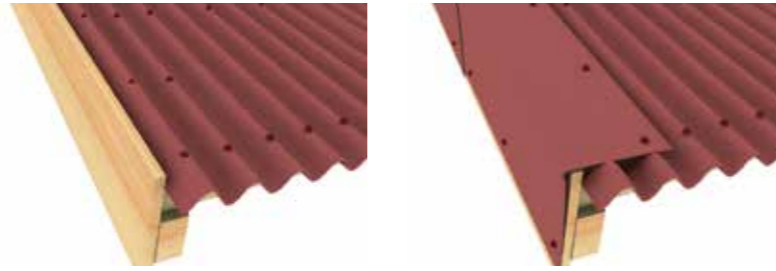

COVERING WITH AN ONDULINE SHEET CORRUGATION

- 1 - Fasten bargeboard to reach the underside of ONDULINE of overhang corrugation.
- 2 - Fold down and nail into position.

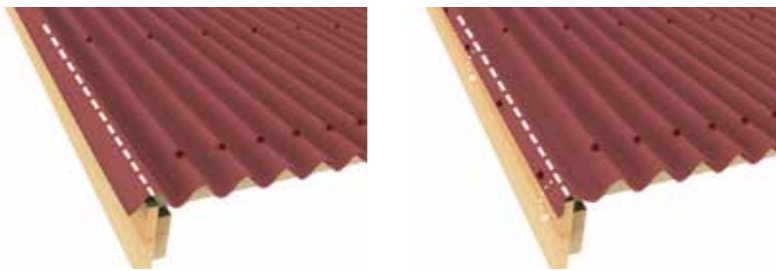

COVERING WITH A METAL FLASHING VERGE UNIT

- 1 - Fasten bargeboard level with top of finished ONDULINE roof.
- 2 - Covering with the metal verge unit is then overlaid and nailed into position.

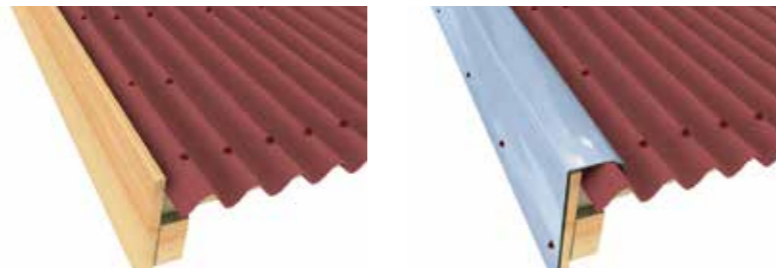

2.3 EAVES

The sheets overhang at the eaves should not be more than 7 cm. Please set this distance while elaborating the roof project.

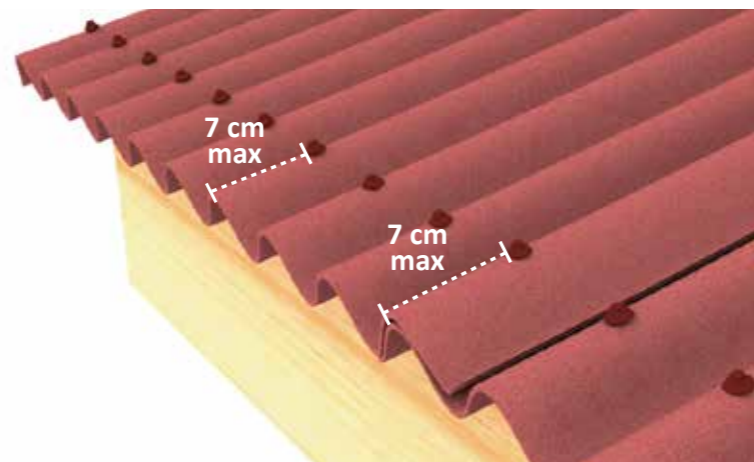

2.4 HIP DETAIL



- Fix the hips before the ridge element.
- Overlay with the hip elements and fix it as shown on the picture.

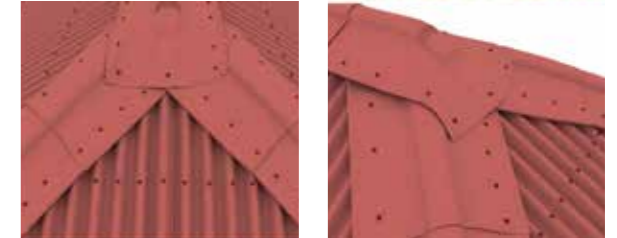

2.5 EAVES TRAY

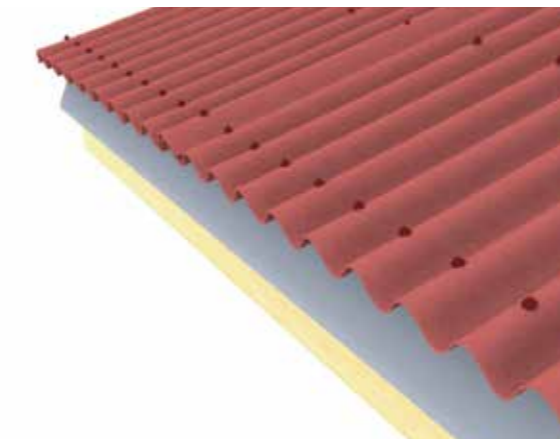

- Developed for oversheeting applications with ONDULINE Sheets.
- The eaves tray can also be used to reduce the overhang at eaves and provides waterproofing.

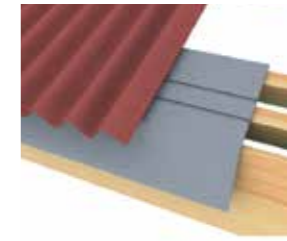

2.6 EAVES VENTILATION STRIP

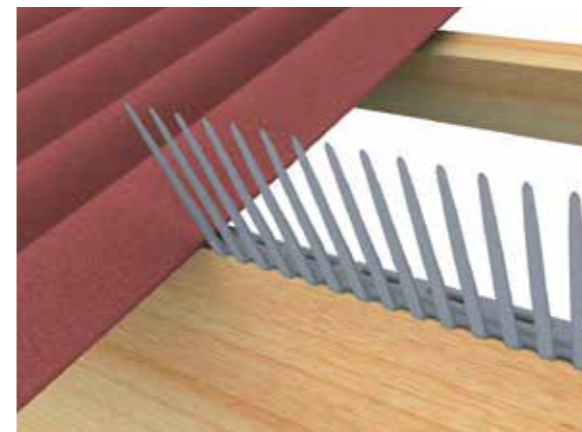

- Fix the ventilated strip on the purlin to stop ingress of birds and rodents.

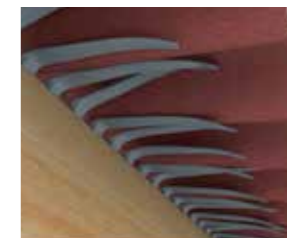

2.7 END WALL ABUTMENTS

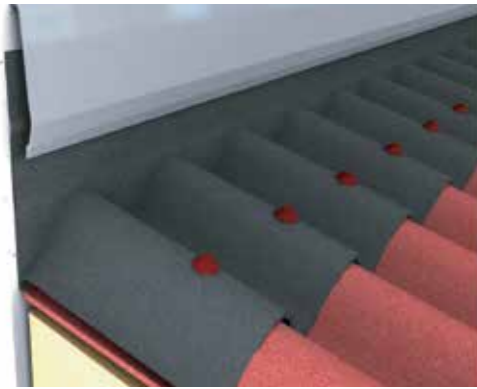

ONDULINE ABUTMENT APRON FLASHING

- 1 - Use ONDULINE pre-formed apron flashing to seal end the wall abutment enabling the ventilation.
- 2 - Use a separate cover flashing for the wall.

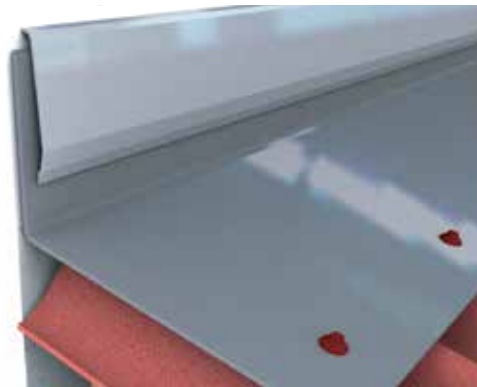

3RD PARTY FLASHING

- 1 - Use ONDULINE pre-formed plate of metal to seal end wall abutment enabling the ventilation.
- 2 - Use a separate cover flashing for the wall.



2.8 SIDE WALL ABUTMENTS

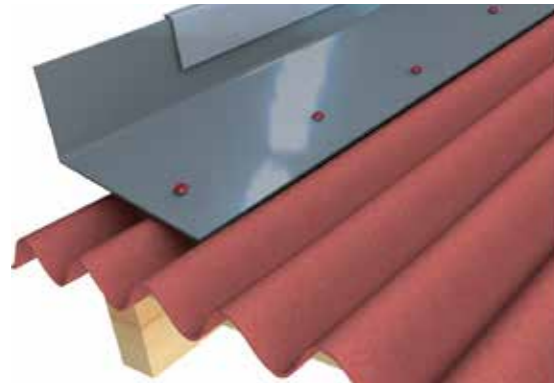

HARD COVER FLASHING TO WALL

- 1 - Use a pre-formed plate of metal flashing to seal side wall abutment. Take into consideration the possible dilation while drilling.
- 2 - Use separate cover flashing to the wall to allow for movement.

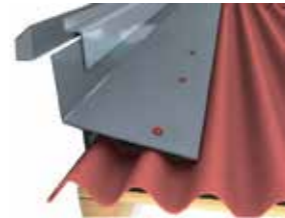

ONDULINE FLASHING TAPE TO WALL

- 1 - Use a pre-formed plate of metal flashing to seal side wall abutment. Take into consideration the possible dilation while drilling.
- 2 - Use ONDULINE flashing tape (ONDUBAND) as cover flashing to the wall.

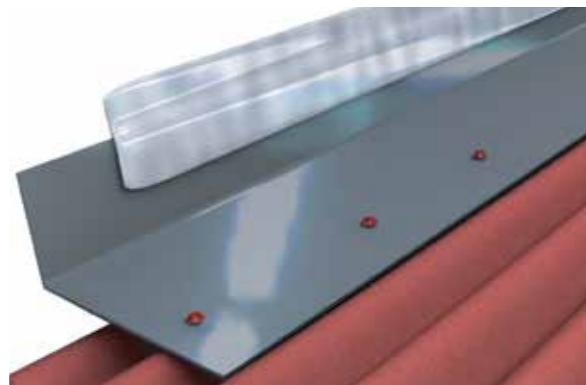

2.9 END ROOF

USING ONDULINE RIDGE UNIT

- Fit ridge board and purlin. The ONDULINE ridge unit is then overlaid and nailed or screwed into position.

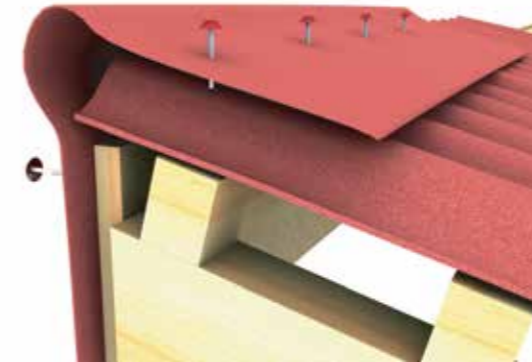

USING A PIECE OF METAL RIDGE ELEMENT

- Fit metal ridge element and purlin. The metal ridge element is then overlaid and nailed or screwed into.

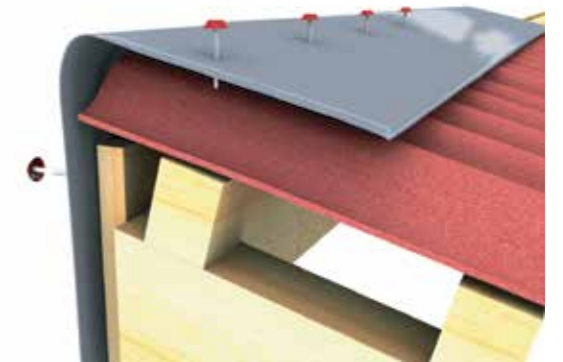

2.10 VALLEY

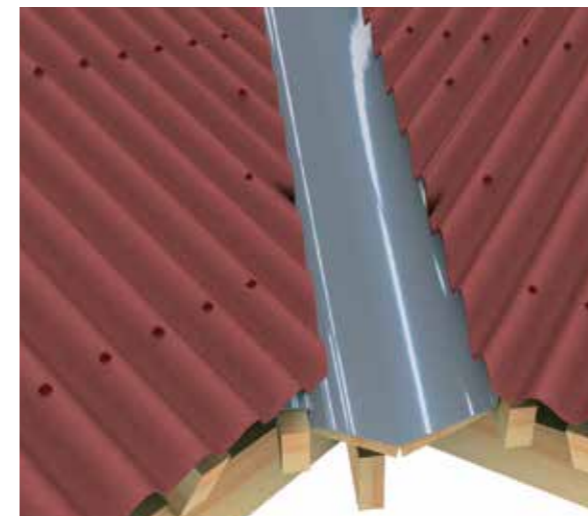

USING A PLATE OF METAL

- Fix valley board / trim purlin and line with metal pre-formed unit.
- The vertical valley depth should be sufficient to allow the water to flow.
- The sheets are cut across (parallel to the valley line). The overhang is max 4 cm.

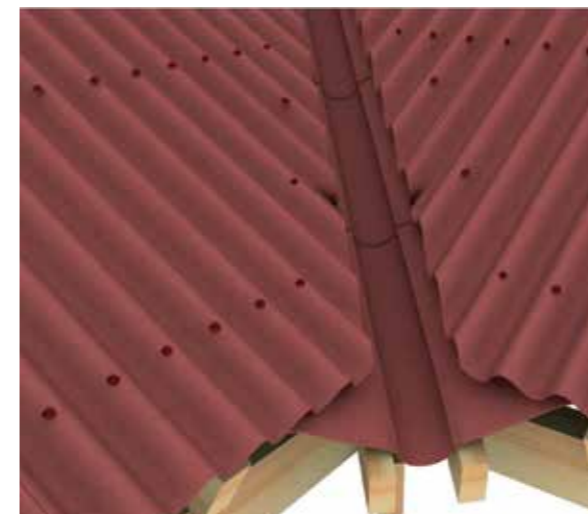
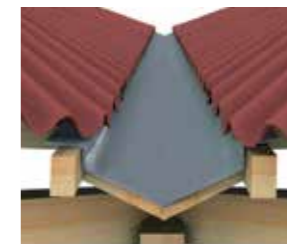

USING ONDULINE VALLEY

- Fix valley board / trim purlin and line with ONDULINE valley.
- The vertical valley depth should be sufficient to allow the water to flow.
- The sheets are cut across (parallel to the valley line). The overhang is max 4 cm.



2.11 ONDULINE ROOF WINDOW

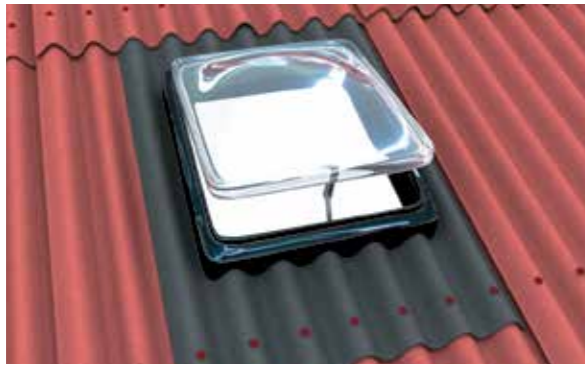

- Provides lighting and ventilation but does not reduce the thermal insulation performance of the roof.
- Cut opening in the sheet and nail in position.



2.12 SKYLIGHT - ONDUCLAIR

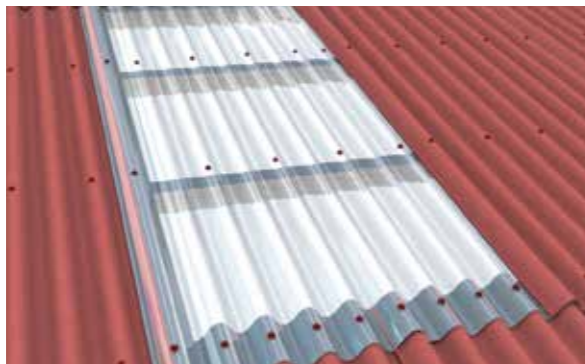

- Perfect complement to the ONDULINE corrugated sheet.
- Please refer to the manufacturer specific fixing guide on installation for the different types of ONDUCLAIR Skylight products.



2.13 ROOF VENTILATOR



- Roof ventilator with free air space to provide increased ventilation.
- Simply cut an opening in the sheet and nail in position according to the fixing instructions provided with the product.

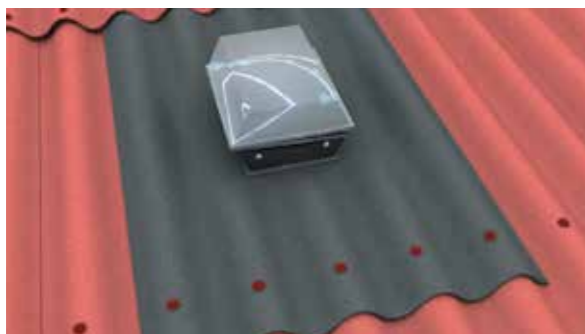
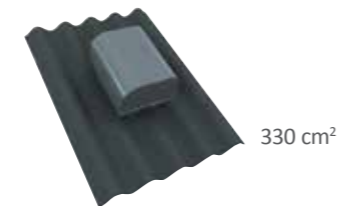

2.14 CHIMNEYS

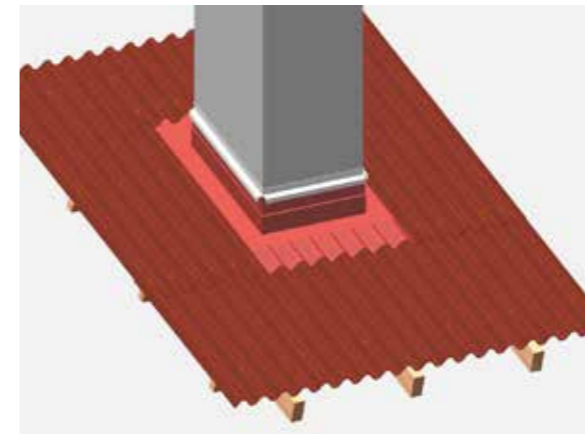
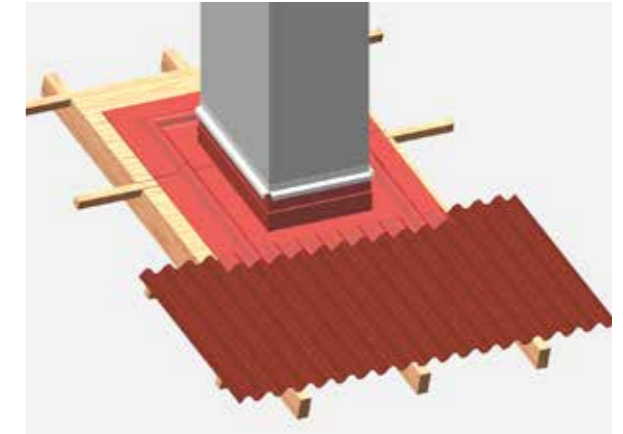
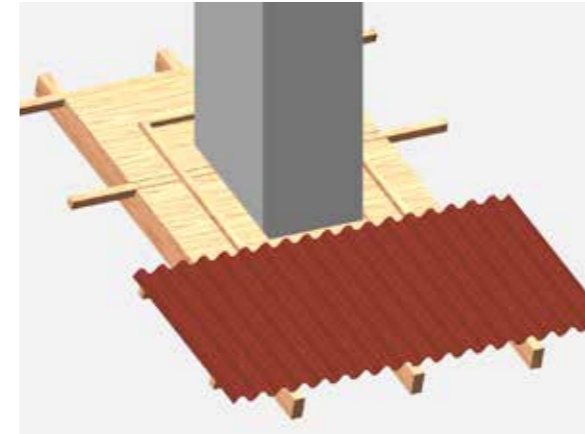

- Fixing must be done to make it totally waterproof and ensure no water accumulation at the back.
- Full deck is necessary for the roof part around the chimney. Surround the chimney with a batten of 3cm x 3cm entering the corrugations of the sheets installed at the lower part of the roof.
- Apply a layer of ONDUBAND® Pro around the chimney, covering also the battens. Finish upper edge of ONDUBAND® Pro with the Z profile.
- Zinc or GRP chimney flashing can also be used.

2.15 CURVED ROOFS / DOMES

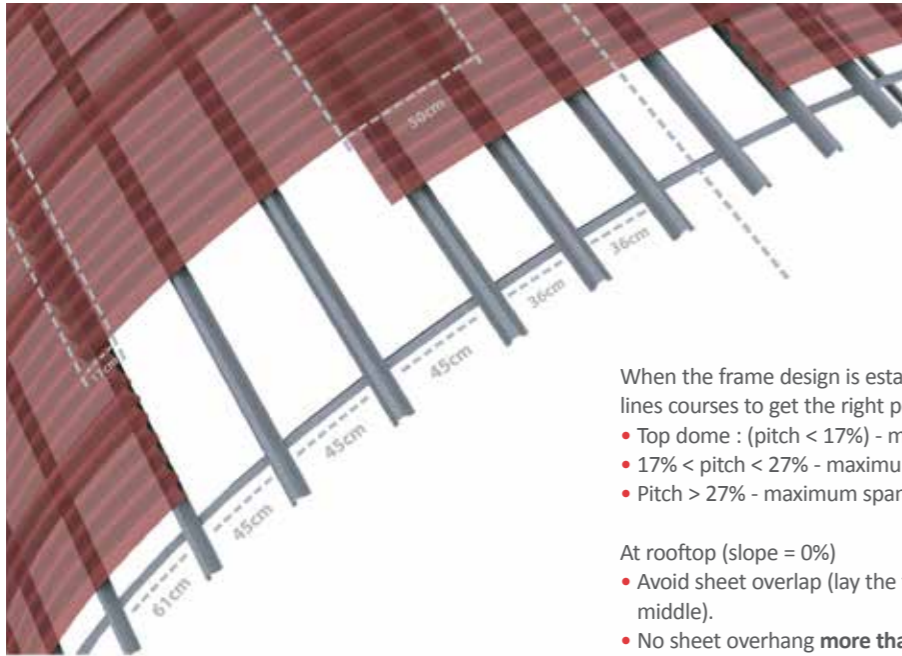

When the frame design is established, continuously setup the lines courses to get the right positions of purlins :

- Top dome : (pitch < 17%) - maximum span is **36 cm**.
- 17% < pitch < 27% - maximum span is **45 cm**.
- Pitch > 27% - maximum span is **61 cm**.

At rooftop (slope = 0%)

- Avoid sheet overlap (lay the top sheet centered in its middle).
- No sheet overhang **more than 7 cm**.
- Side lap : **2 corrugations**.

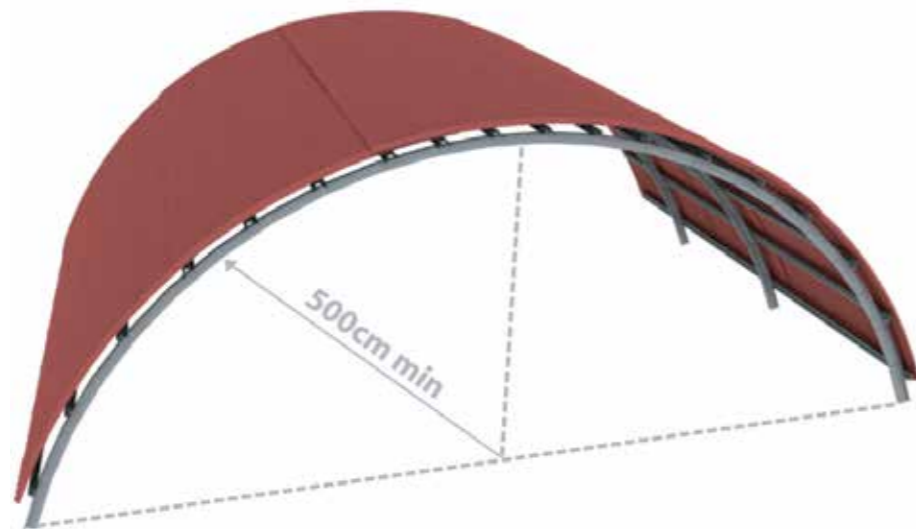

3. PRODUCT SPECIFICATIONS

3.1 ONDULINE CLASSIC SHEET

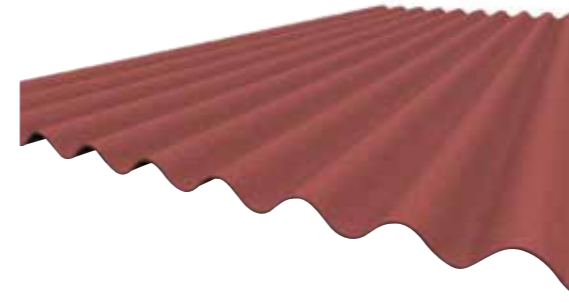

- The original bitumen-saturated corrugated roofing sheet with characteristics, versatility and benefits that are suitable and applicable for most types of building and others use such as undersheeting, overshooting and wall-cladding.

- Available in Black, Brown, Red and Green.

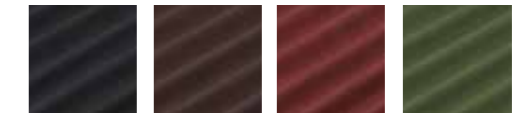

3.2 ONDULINE RIDGE



- Manufactured from the same material and quality as ONDULINE Classic. Flexible double wings accommodate a wide range of roof angles.

- Available in same 4 colors as the ONDULINE Classic.



3.3 ONDULINE VERGE

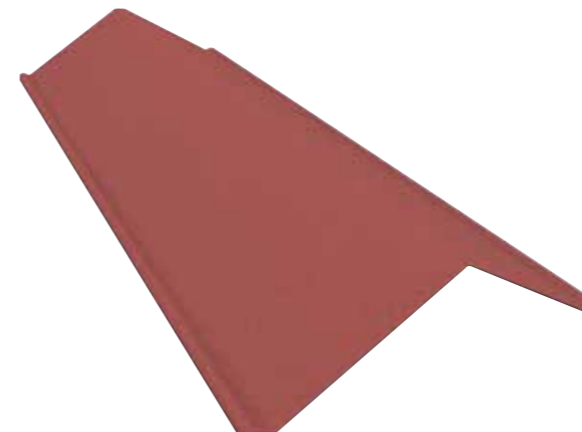

- Designed to provide a weatherproof seal at the verge, this unit is made from the same quality material as ONDULINE Classic.

- Available in same 4 colors as the ONDULINE Classic.



3.4 ONDULINE NAIL



- The washer is resistant to UV radiation and with its weatherproof seal provides an adequate resistance to wind uplift.
- Available in same color ranges as the sheets.

3.5 ONDULINE SCREW



- ONDULINE® Screw can be fixed on wood or steel purlins using a power drill. This self-tapping screw has a PVC washer to prevent the sheet riding up on the thread. It enables correct tension to be achieved avoiding over tightening and distortion.

- Available in same color ranges as the sheets.

3.6 ONDUBAND®



- Multifunction self-adhesive type, which can be used for the waterproofing of the chimney, valley...

3.7 ONDULINE MULTI-PURPOSE EAVES TRAY

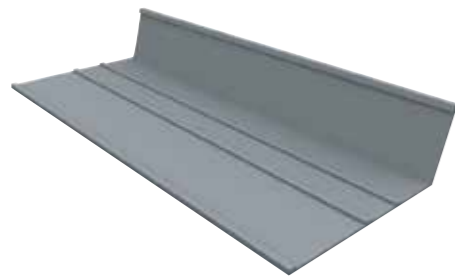

- Used underneath ONDULINE sheets on an existing full deck roof to avoid the repositioning of the gutter. It also allows the reduction of the sheet overhang at the eaves.
- When overshooting on asbestos roof, it avoids the cutting of the existing sheets at the eaves.

3.8 ONDULINE VENTILATED EAVES FILLERS



- It is fixed at eaves to allow ventilation and to prevent the ingress of birds and rodents.

3.9 ONDULINE ROOF VENTILATORS



- With the insertion of a pipe adaptor, this unit can be converted to soil vents.
- Weatherproof under the most adverse conditions.
- The modern design facilitates quick and easy installation.

3.10 ONDULINE ROOF WINDOW / SKYLIGHT

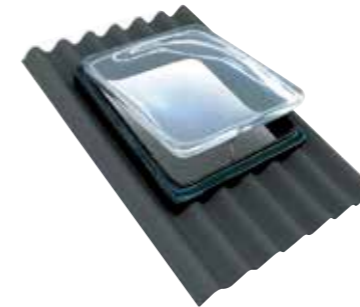

- The ONDULINE Roof Window/Skylight provides light and air to the roof and also serves as an exit to roof areas.
- Same corrugation size as ONDULINE products.
- Modern design prevents infiltration of snow and rain.
- Quick and easy to install.

3.11 ONDULINE APRON FLASHING



- Manufactured from Polypropylene, this apron flashing is designed to seal the gap between ONDULINE sheets, and vertical wall abutment.
- Suitable for any roof pitches.

3.12 ONDULINE SOIL PIPE

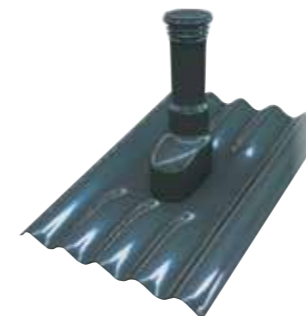

- For drainage system ventilation, this product fully matches the ONDULINE profile to ensure a completely weatherproof seal.

4. VENTILATION

! When designing a roof, you should ensure proper ventilation of the roof.

4.1 ROOF VENTILATION

BEWARE OF THE RISK OF CONDENSATION AND ITS CONSEQUENCES

There is always water inside every heated space such as the kitchens and bathrooms of residences, indoor swimming pools, factories with lots of water usage, barns or poultry houses where a great number of animals discharge heat and moisture from their bodies. Vapor condenses immediately if it comes in contact with cold surface of the building walls. If vapor condenses within building material of the roof construction, it can generate serious problems by causing damages such as blooming and mold on ceiling (fig. A).

Ventilating the roof space prevent condensation and it affects the heat insulation positively as well. In most cases a difference of 10° C can be appreciated between the inside temperature of a non ventilated roof and a ventilated roof with insulation. Furthermore, in regions with cold climate and high precipitation, snow accumulation on ventilated roofs is more homogeneous and excessive pilling on the eaves can be kept under control.

ROOF WITHOUT HEAT INSULATION AND VENTILATION

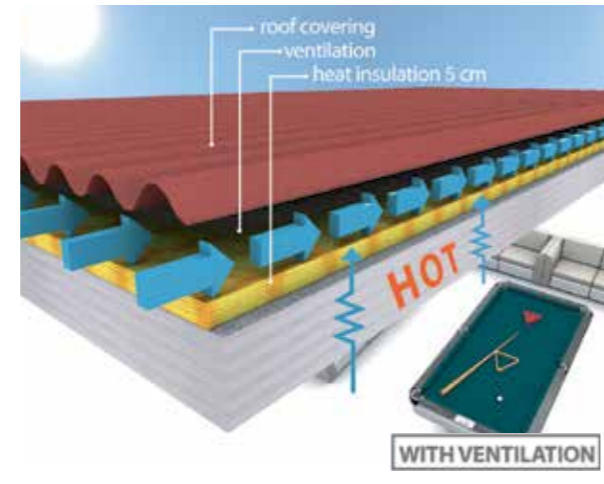
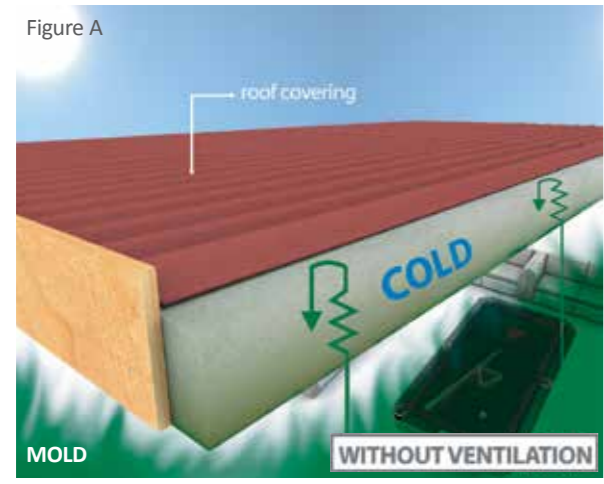

EFFECT OF VENTILATION ON ROOF WITH SNOW ACCUMULATION



4.2 RELATIVE HUMIDITY / MOISTURE LEVEL WITHIN BUILDING

The balance between the contribution of water (w in g/m³) and the ventilation rate (n) determine the relative humidity. The moisture level depends on the ratio w/n.

Ratio w/n (g/m ³)	Moisture level
< 2.5	Low
From 2.5 to 5	Medium
From 5 to 7.5	High
> 7.5	Very high

ONDULINE Classic and **Plus** sheets are recommended for moisture level from low to medium i.e w/n (g/m³) < 5. If it is not the case, we recommend to diminish the moisture level by appropriate means (vapor barrier, additional ventilation...).

VENTILATION

Ventilation shall be provided by two series of openings permitting air entry and exit; the minimum cross-sectional area for each series is 1/800th of the total roof area. Corrugations provide a ventilation area of 170 cm² per meter.

! Do not close these openings at eaves and ridges, it would prevent the air movement.

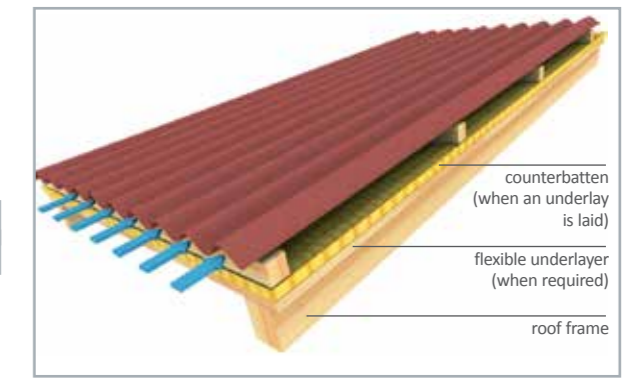

ROOF USING RIDGE

Inlet and outlet ventilation areas provided by **ONDULINE Classic**: 170 cm² per meter (for an horizontal length = 1 meter)

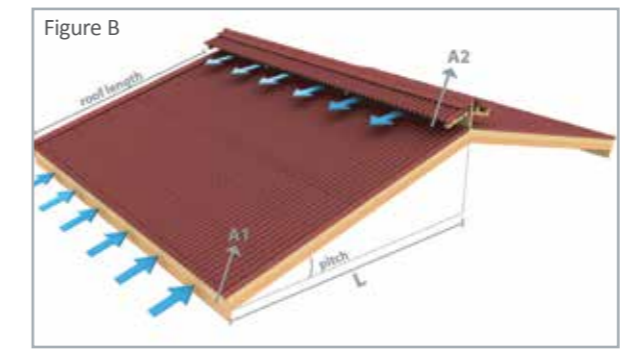

A1 = A2 = Distributed ventilation inlets and outlets needed (in cm²): Ventilation openings A1 and A2 should be provided at each eave and at the roof ridge (see figure B).

If the roof pitches are longer than 12 meters, an extra opening should be included at an intermediate point on the pitch. Refer to the following chart to determine the ventilation needs especially for low pitches less than 15°.

Roof length (m)	Pitch 20% Angle 11,3°	Pitch 30% Angle 16,7°	Pitch 40% Angle 21,8°	Pitch 50% Angle 26,5°
5	corr	corr	corr	corr
8	200	corr	corr	corr
10	250	corr	corr	corr
15		180	174	168
18		216	209	201
20		239	232	224

With ONDULINE, it is better to avoid low pitches combined with big roof lengths.

N.B : These are average values for Northern Europe. For other countries, please contact the technical department in the respective country.

- For roof length < 10 meters, ventilation is provided by corrugations of ONDULINE classic
- For low pitches between 10 and 15 meters, A.V = 200 cm²
- For low pitches (< 15 meters), A.V = 250 cm²

Extra openings are usually performed with ONDULINE aerators G 3 (additional ventilation of 110 cm²) or WG 33 (330 cm²) that are designed according to ONDULINE profile.

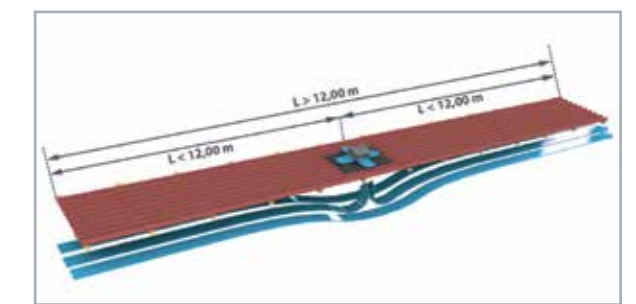

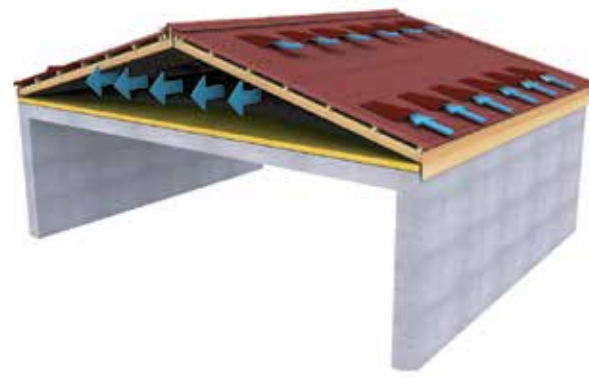

In order to obtain desired efficiency from ventilation, air inlet and outlet locations should be adequately dimensioned and selected according to the roofs physical properties. In principle, air movement is upward, air inlets should be arranged at the eaves while the air outlets are at the ridge level : special attention should be paid that no elements block the air flow on the eaves and ridge line air. If there is any unused space between the roof and the last slab, ventilation can be created by having air inlets and outlets being placed on the roof at intervals.

4.3 VENTILATION BETWEEN ROOF LAYERS

If ventilation is between the roof layers only, continuous air inlet and outlet locations should be established and unblocked.

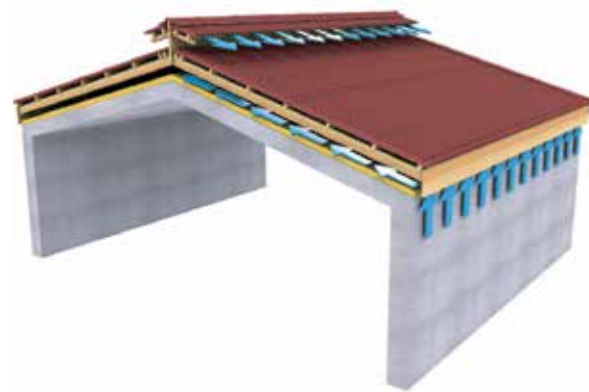

Narrow buildings with high pitched roofs are better ventilated when compared with wide buildings with lowpitched roofs. That is why the horizontal distance between the eaves and ridges and the roof inclination must be taken into consideration when determining the space necessary for ventilation.

5. CERTIFICATES

GENERAL TESTS AND TECHNICAL AGREEMENTS



- CSTB (France). AT 5/10-2094. AT 5/03/1690. AT 5/9 1424
- BBA (UK): A.C.87/1823 C
- ITB (Poland): 500 / 02 AT 1 2145 / 2002
- Conformity to EN 534 general performance and attitude tests
- ISO 9001:2008
- ISO 14001



Strength and Impact Loading

- Warrington Research Laboratory Test (UK) BS1811.
- United States Testing Co. ASTM D 1502-60
- CEBTP (France): Report no 2342.7.098
- Bureau Veritas (France): BTE JPD / NC 1016 / 1995
- CSTB: NO GM/92-20

Test showed adequated bearing strength, impact resistance and resistance to wind lift



Mechanical Resistant

- Warrington Research Laboratory Test (UK) BS4154.
- Showed resistance to 73lbs sheered force on fixing bolt.



Water Absorption

- Warrington Research Laboratory Test (UK) BS1811. Showed minimal absorption.
- ASTM E96 (USA). Performed excellently in moisture vapour transmission and showed only minimal absorption.
- DIN 52103 (Germany) Showed no effects after 16 days when immersed.



Water and Weather Proofing

- Tests (UK) BS1811 and ASTM D1499 (USA).
- UIDIEM (Chile): Certificate NO 150 385
- Test showed excellent weather-proofing characteristic.



Heat Deformation

- Warrington Research Laboratory Test (UK). Tropical investigation test showed no visible effects.
- Yarsley Research Centre Test (UK) Middle east suitability tets up to 70OC proved complete suitability in severe humidity and under all foreseeable conditions.



Thermal Resistance (Insulation)

- ASTM C177-76 (USA) and BS874 (UK). Showed excellent thermal resistance K value 0.46 to 0.51 British Thermal Unit
- LNE (France): Certificate NO 7070916 D MAT/1 Thermal conductivity : 0.099W/mK



Wind resistant

- Yarsley Research Centre (UK). Proved ONDULINE suitable in hurricane and earthquake conditions. Tested up to 120 mph (192kph)
- Building Research Establishment (UK): NO BRE/83/11/1 Good behavior in wind lift conditions
- Wood Technology Division (New Zealand): NO WTC 1468/2 Good behaviour in cyclonic conditions
- Minister of Economic (Argentina): NO 83-1 INPRES 95 & PV NO 030 DPU-95



Hail / Frost Resistance

- ASTM E196 (USA) and DIN 52103 dan 52104 (Germany). Meets snow and frost resistance for all regions. No mechanical damage in frost



Toxicity and resistance to chemicals Test

- Yarsley Research Centre (UK) Tests carried out on water collected after catchments with ONDULINE sheets give water suitable for drinking complying with World Health Organization and EEC regulations.
- CSTB (France): NO SM/98-0062 Good behaviour under exposure to acids, alkalis, and salts.



Acoustical Insulation

- CEBTP No 2312.6.244/1 Reverberation coefficient (max): 0.4 to 315 Hz
- CSTB C/95/CL/1896/1 Sound attenuation coefficient (max) : Rw = 28 dB
- Wolfson unit Southampton University (UK). NO 2089 1592/B1 : Antenoise wall with ONDULINE reduces the airborne noises of 7 dB.

6. GENERAL INFORMATION

PRECAUTIONS ON ROOF USAGE

Roof traffic

Only walk on the roof if this is necessary. To distribute the loads, planks or ladder should be laid flat and by the roof purlins to carry out maintenance and related work. All precautions should be taken and safety regulations must be observed and applied.

Roof maintenance

Maintenance of the roof is the responsibility of the owner. To ensure long life we recommend that the following maintenance procedures are carried out.

- Remove moss and debris. Do not allow leaf debris to build up on the surface of the corrugated roofing sheets, the debris will form leaf mould which can soften the material and reduce the effective life of the product.
- Check that branches are not in contact with the roof surface as wind generated movement can result in mechanical damage to the surface of the sheets.
- Clean all rainwater gutters, down-pipes and gullies regularly ensuring efficient water run-off from the roof.
- Maintain a good state of roof elements such as flashing, chimney stacks, etc.
- Maintain a good state of the roof and its ventilation.

SITE STORAGE

ONDULINE is delivered to site on pallets of 150 to 420 sheets (depending on means of transport and sheet specification) shrink wrapped. It is not recommended to stack pallets. Sheets must be stored flat and covered at all times to protect against weather and dust. In hot climates ONDULINE must be protected from direct sunlight.

HANDLING

ONDULINE may be stored in freezing temperatures but installation should not be attempted in these conditions. ONDULINE should be lifted from the pallet, not dragged across it. The material should then be handled using conventional techniques for corrugated sheeting.

TECHNICAL SERVICES

ONDULINE provide a comprehensive technical and laboratory advice service for all applications of ONDULINE system. Please always refer to our specific technical guides for complete installation details and check with our representative, your local dealer or your specifier for your country building codes and regulations.

RE-USE OF ONDULINE SHEETS

In the event of sheets having to be removed from a roof or side wall, the nails are extracted with an ordinary claw hammer levered against a piece of wood shaped to the corrugation. ONDULINE sheets thus recovered may be used again - an important economical aspect.

PRECAUTIONS

When using ONDULINE in conditions of high internal humidity it is important to use a vapour barrier and adequate ventilation on the roof space.

CONDITIONS OF SALE

The color impregnation is long lasting, but weathering effects cannot be entirely discounted and will affect ONDULINE in the same way as they affect natural material roofs. The ONDULINE group assumes no responsibility for the effect of structural movement. Details are correct at the time of printing, but the manufacturers reserve the right to vary specifications and details at any time without notice. To avoid any possible misunderstandings, we require that a customer seeking advice on suitability or performance of goods or relating to the nature of services supplied should put such requirements to us in writing. Goods are not tested or sold as fit for any particular purpose unless so agreed in writing. There might be slight variations in size, weight and color.

HEALTH AND SAFETY

The photographs and drawings in this brochure are of installations in many parts of the world; building practices shown may not therefore comply with the recommended safety standards in other countries.



This Technical data folder has been prepared by Onduline SA and pursuant to the Intellectual and Artistic Works Law, its copyright, right of publication and all other relevant rights in any language and all over the world are reserved. None of the writings, photographs and drawings published in this manual may in no way be used, or quoted partially or wholly, without showing their source, nor they may be copied, multiplied or published.



www.onduline.com

Onduline
35, rue Baudin
92300 Levallois-Perret
FRANCE

